



Newland

SCANNING MADE SIMPLE



NQuire 300 series customer information terminal SDK handbook

Revision History

Version	Description	Date
V1.0.0	Initial release.	June 7, 2017

Table of Contents

Running ADB.....	1
Barcoding Scanning	4
1. Scan Barcode.....	4
2. Obtain Barcode Data	4
3. Change the Scanner Settings	6
4. Symbology ID Number	7
NFC/RFID	8
1. Basic Configurations	8
2. Read/Write NDEF Tags	9
1) Write NDEF Data to an NFC Tag	9
2) Read NDEF Data from an NFC Tag.....	12
3. Read/Write Non-NDEF Tags	13
1) Directly Write to Mifare Ultralight page.....	13
2) Directly read Mifare Ultralight page.....	15
GPIO Programming.....	16
Launch Application on Boot.....	18

Running ADB

ADB (Android Debug Bridge) tool can be used to debug apps developed for the NQuire300. The following describes how to run the ADB.

1. Turn on the NQuire300. If it displays other screen other than the desktop, scan the **Enter Setup** barcode then **Return to Desktop** barcode to return to the desktop.

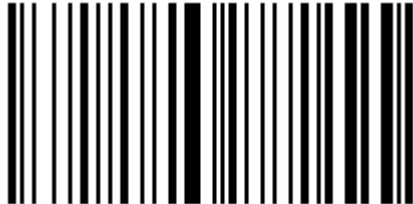

Enter Setup

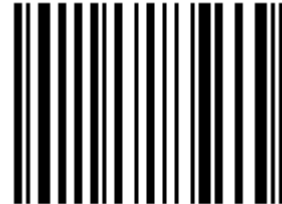

Return to Desktop

2. Tap “Settings” on the desktop.

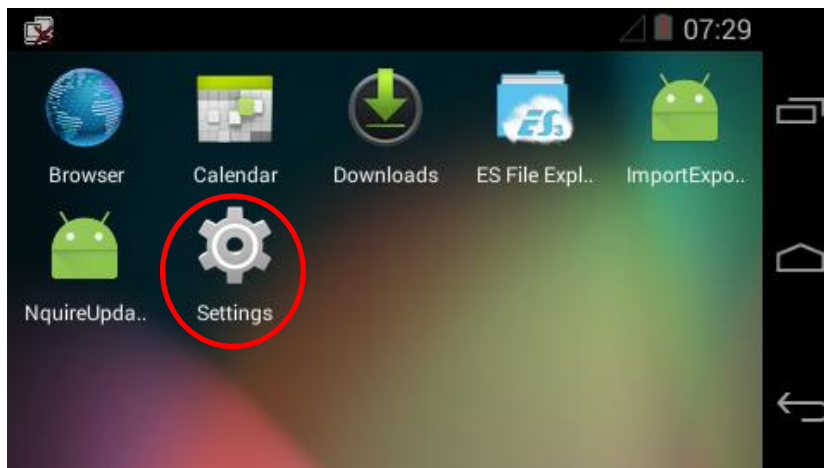

3. Tap “About tablet”.

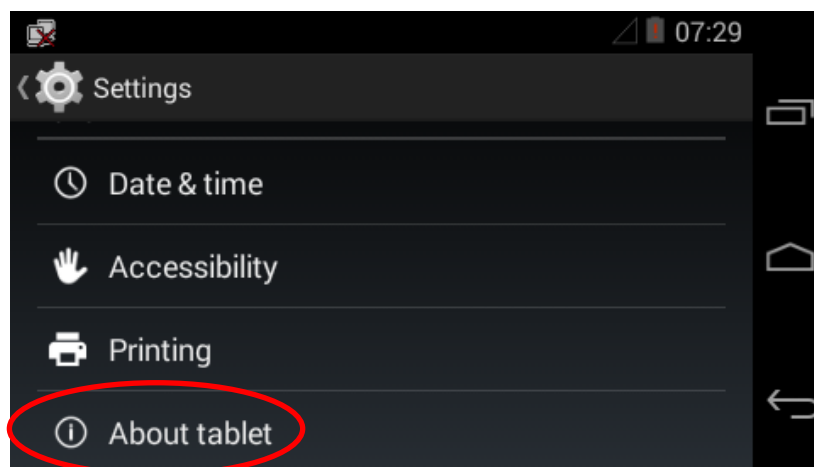

4. Tap “Build number” 7 times to become a developer.

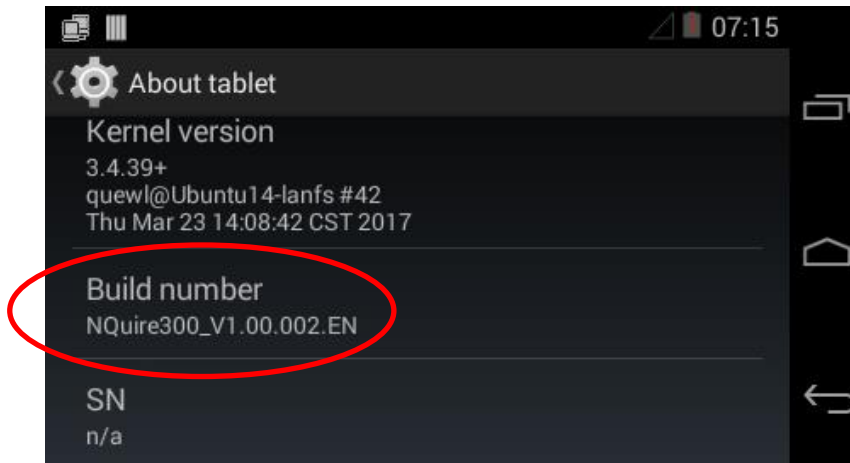

5. Tap  to return to the previous screen.

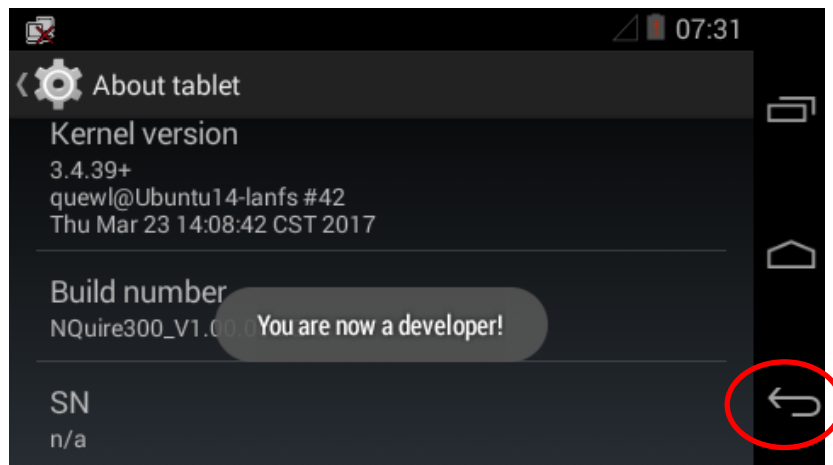

6. Tap “Developer options”.

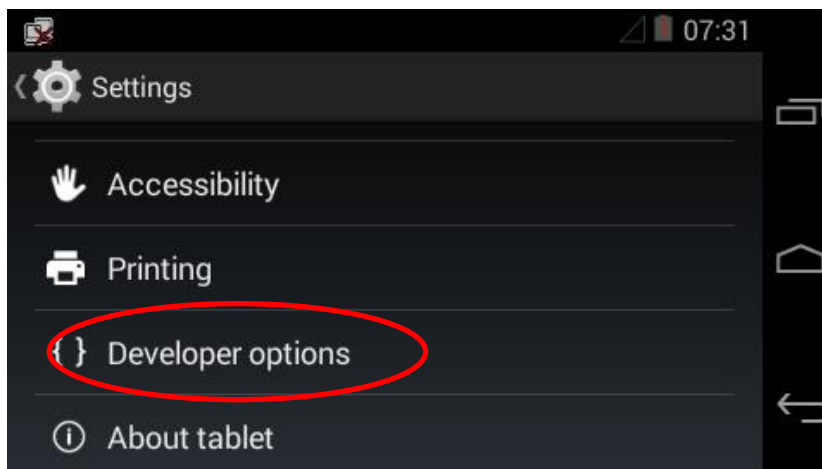

7. Select "Enable OTG".

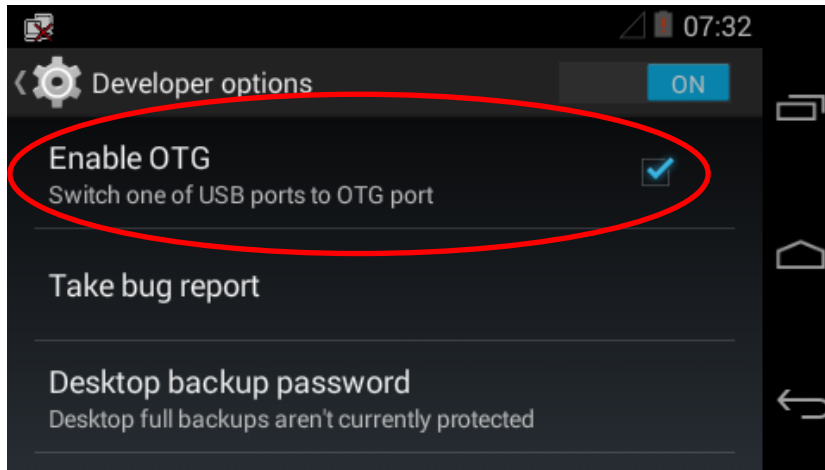

8. Connect the USB Host/Slave port on the NQuire300 to PC with a USB cable.

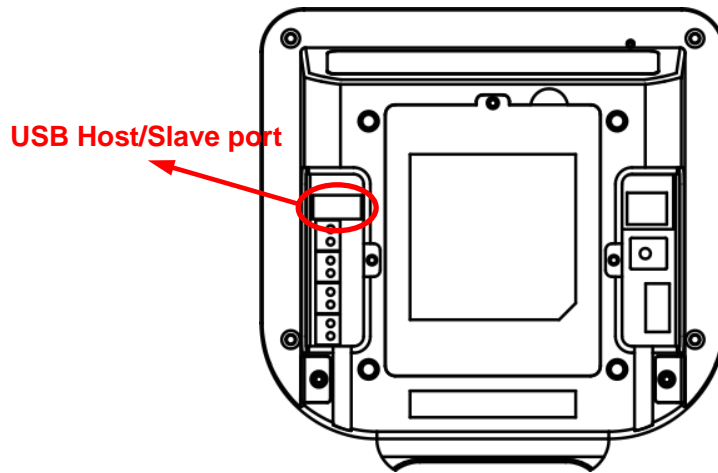

9. Tap "OK".

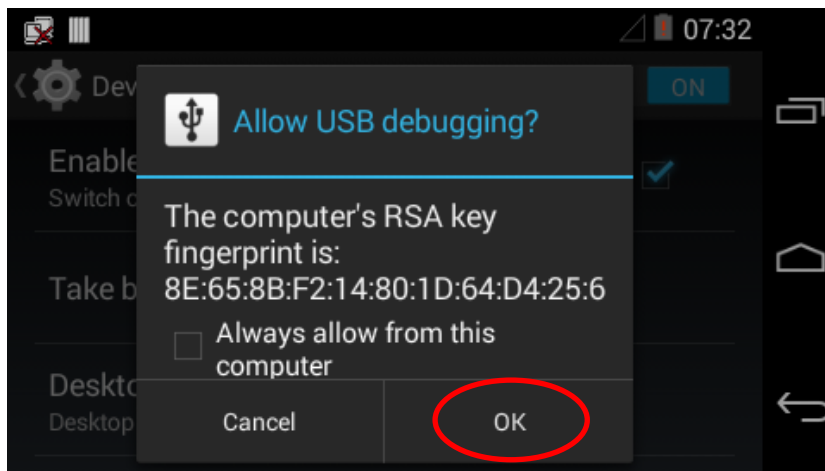

Barcoding Scanning

The NQuire300's ScanAPI is built based on standard Android broadcast mechanism, so there is no need for additional SDKs. The NQuire300 application development environment is the same as Android application development environment.

1. Scan Barcode

The NQuire300 will automatically activate when a barcode is detected and thus there is no extra control required from your application for triggering a scan.

2. Obtain Barcode Data

There are three ways to obtain barcode data:

1. Fill in EditText directly: Output scanned data at the current cursor position in EditText.
2. Simulate keystroke: Output scanned data to keyboard buffer to simulate keyboard input and obtain the data at the current cursor position in TextBox.
3. Output via API (default): Application obtains scanned data by registering a broadcast receiver and listening for specific broadcast intents.
 - Broadcast: **nlscan.action.SCANNER_RESULT**
To obtain barcode data.
 - Extra scan result 1 parameter: **SCAN_BARCODE1**
Type: String
To obtain the data of the barcode scanned.
 - Extra scan state parameter: **SCAN_STATE** (value: fail or ok)
Type: String
To obtain the status of scan operation: Value = fail, operation failed
Value = ok, operation succeeded
 - Extra symbology ID number parameter: **SCAN_BARCODE_TYPE**
Type: int (-1 indicates failure to obtain symbology ID number)
To obtain the ID number of the barcode scanned (Refer to the "Symbology ID Number" section to get the barcode type).

The following code example is an example of setting the scanner parameters (enable the Output via API mode; do not add a line feed; turn Good Read LED on), scanning barcode and acquiring barcode data and barcode type.

```

private void registerBarcodeScannerBroadcastReceiver() {
    //Enable the Output via API mode; do not add a line feed; turn Good Read LED on
    Intent intent = new Intent ("ACTION_BAR_SCANCFG");
    intent.putExtra("EXTRA_SCAN_MODE", 3);
    intent.putExtra("EXTRA_SCAN_AUTOENT", 0);
    intent.putExtra("EXTRA_SCAN_NOTY_LED", 1);
    sendBroadcast(intent);
    registerReceiver(barcodeScannerBroadcastReceiver, new IntentFilter("nlscan.action.SCANNER_RESULT"));
}

private void unregisterBarcodeScannerBroadcastReceiver() {
    unregisterReceiver(barcodeScannerBroadcastReceiver);
}

private BroadcastReceiver barcodeScannerBroadcastReceiver = new BroadcastReceiver() {

    @Override
    public void onReceive(Context context, Intent intent) {
        final String scanResult_1=intent.getStringExtra("SCAN_BARCODE1");
        final String scanStatus = intent.getStringExtra("SCAN_STATE");
        if (null==scanResult_1 || null==scanStatus
            || scanResult_1.isEmpty() || scanStatus.isEmpty()) {
            return;
        }
        if ("ok".equals(scanStatus)) {
            tvBarcode.setText(scanResult_1);
            int codeId = intent.getIntExtra("SCAN_BARCODE_TYPE", -1);
            tvCodeId.setText(""+codeId);
        }
    }
};

```

3. Change the Scanner Settings

Application can set one or more scanner parameters, such as enable/disable scanner, by sending to the system the broadcast ACTION_BAR_SCANCFG which can contain up to 3 parameters.

Parameter	Type	Description (* indicates default)
EXTRA_SCAN_POWER	INT	Value = 0 Disable scanner = 1 Enable scanner* Note: When scanner is enabled, it will take some time to initialize during which all scan requests will be ignored.
EXTRA_TRIG_MODE	INT	Value = 1 Continuous mode = 2 Normal mode*
EXTRA_SCAN_MODE	INT	Value = 1 Fill in EditText directly = 2 Simulate keystroke = 3 Output via API*
EXTRA_SCAN_AUTOENT	INT	Value = 0 Do not add a line feed* = 1 Add a line feed
EXTRA_SCAN_NOTY_SND	INT	Value = 0 Turn Good Read beep off = 1 Turn Good Read beep on*
EXTRA_SCAN_NOTY_LED	INT	Value = 0 Turn Good Read LED off = 1 Turn Good Read LED on*

The following code example is an example of setting the scanner parameters (enable the Output via API mode; do not add a line feed; turn Good Read LED on) and registering a broadcast receiver for barcode scanning intent.

```
private void registerBarcodeScannerBroadcastReceiver() {  
    // Enable the Output via API mode, do not add a line feed, turn Good Read LED on  
    Intent intent = new Intent ("ACTION_BAR_SCANCFG");  
    intent.putExtra("EXTRA_SCAN_MODE", 3);  
    intent.putExtra("EXTRA_SCAN_AUTOENT", 0);  
    intent.putExtra("EXTRA_SCAN_NOTY_LED", 1);  
    sendBroadcast(intent);  
    registerReceiver(barcodeScannerBroadcastReceiver, new IntentFilter("nlscan.action.SCANNER_RESULT"));  
}
```

4. Symbology ID Number

ID Number	Symbology	ID Number	Symbology
2	CODE128	39	CODE49
3	UCCEAN128	40	CODE16K
4	AIM128	41	HIBC128
5	GS1_128	42	HIBC39
6	ISBT128	43	RSSFAMILY
7	EAN8	256	PDF417
8	EAN13	257	MICROPDF
9	UPCE	258	QRCODE
10	UPCA	259	MICROQR
11	ISBN	260	AZTEC
12	ISSN	261	DATAMATRIX
13	CODE39	262	MAXICODE
14	CODE93	263	CSCODE
15	93I	264	GRIDMATRIX
16	CODABAR	265	EARMARK
17	ITF	266	VERICODE
18	ITF6	267	CCA
19	ITF14	268	CCB
20	DPLEITCODE	269	CCC
21	DPIDENTCODE	270	COMPOSITE
22	CHNPOST25	271	HIBCAZT
23	STANDARD25	272	HIBCDM
23	IATA25	273	HIBCMICROPDF
24	MATRIX25	274	HIBCQR
25	INDUSTRIAL25	512	POSTNET
26	COOP25	513	ONECODE
27	CODE11	514	RM4SCC
28	MSIPLESSEY	515	PLANET
29	PLESSEY	516	KIX
30	RSS14	517	APCUSTOM
31	RSSLIMITED	518	APREDIRECT
32	RSSEXPADED	519	APREPLYPAID
33	TELEPEN	520	APROUTING
34	CHANNELCODE	2049	ZZCODE
35	CODE32	2050	EAN413
36	CODEZ	2051	EAN414
37	CODABLOCKF	2052	EAN419
38	CODABLOCKA		

NFC/RFID

The NQuire300 is equipped with NFC module. Android NFC API (android.nfc) can be used to develop NFC/RFID applications. The NFC-enabled NQuire300 supports three modes of operation: reader/writer mode, Card Emulation mode, and P2P mode. For more information, please visit the website: <https://developer.android.com/guide/topics/connectivity/nfc/index.html>. The following gives a brief description of Android application development of NFC reader/writer mode.

1. Basic Configurations

Add permission to access NFC hardware in the Android manifest file:

```
<uses-permission android:name="android.permission.NFC" />
```

Build an activity for receiving NFC tag data in the Android manifest file:

First, configure activity properties by specifying the launchmode as “**singleTop**” to avoid starting the same activity multiple times in a row.

```
<activity android:name=".MainActivity"
    android:launchMode="singleTop">
```

Second, use **NfcBaseActivity** to initialize NFC before certain NFC operations and use **NfcAdapter.enableForegroundDispatch** method to bring your application to foreground to allow your application to have priority over other applications when an NFC tag is scanned.

```
public class NfcBaseActivity extends AppCompatActivity {

    private final String LOGCAT_TAG = getClass().getSimpleName();

    private NfcAdapter mNfcAdapter = null;
    private PendingIntent mNfcPendingIntent = null;

    @Override
    protected void onCreate(Bundle savedInstanceState) {
        super.onCreate(savedInstanceState);

        mNfcAdapter = NfcAdapter.getDefaultAdapter(this);
        if (mNfcAdapter!=null) {
            Intent nfcIntent = new Intent(this, getClass());
            // If set, the activity will not be launched if it is already running at the top of the history stack.
            nfcIntent.addFlags(Intent.FLAG_ACTIVITY_SINGLE_TOP);
            mNfcPendingIntent = PendingIntent.getActivity(this, 0, nfcIntent, 0);
        } else {
            Log.e(LOGCAT_TAG, "no NFC adapter exists");
        }
    }
}
```

```

    }
}

@Override
protected void onResume() {
    super.onResume();

    if (mNfcAdapter!=null && mNfcPendingIntent!=null) {
        mNfcAdapter.enableForegroundDispatch(this, mNfcPendingIntent, null, null);
    }
}

@Override
protected void onPause() {
    super.onPause();

    if (mNfcAdapter != null) {
        mNfcAdapter.disableForegroundDispatch(this);
    }
}
}

```

2. Read/Write NDEF Tags

NFC Data Exchange Format (NDEF) is a standardized data format specification by the NFC Forum. NDEF data can be stored on many types of tags (such as NXP Mifare Ultralight tags) and exchanged between NFC-enabled devices.

1) Write NDEF Data to an NFC Tag

Build an activity that inherits from **NfcBaseActivity** above. When an NFC tag is detected, system will call **onNewIntent()** and obtain the card number, and then write a custom NDEF message in binary representation to the tag. If the tag is not NDEF formatted, then it needs to be formatted. It is recommended not to perform write operations on the main thread as they may get stuck. The code example below is to perform write operations on a dedicated thread for NFC operations.

```

@Override
protected void onNewIntent(Intent intent) {
    super.onNewIntent(intent);

    final Tag tag = intent.getParcelableExtra(NfcAdapter.EXTRA_TAG);
    if (tag!=null) {
        String cardNr = byteArrayToHexString(tag.getId());
        Log.d(LOGCAT_TAG, "card Number:"+cardNr);
    }
}

```

```

        doWriteNdefTest(tag);
    }
}

private void doWriteNdefTest(final Tag tag) {
    // Connecting, writing may block. Must not be called from the main application thread.
    runOnUiThread(new Runnable() {
        @Override
        public void run() {
            final boolean writeRet = writeNdef(tag);
            runOnUiThread(new Runnable() {
                @Override
                public void run() {
                    if (writeRet) {
                        Toast.makeText(MainActivity.this, "Writing is completed successfully",
Toast.LENGTH_SHORT).show();
                    } else {
                        Toast.makeText(MainActivity.this, "Failed to write this tag", Toast.LENGTH_SHORT).show();
                    }
                }
            });
        }
    });
}

private boolean formatNdef(Tag tag, NdefMessage ndefMessage) {
    boolean ret = false;
    NdefFormatable ndefFormatable = NdefFormatable.get(tag);
    if (ndefFormatable != null) {
        try {
            ndefFormatable.connect();
            ndefFormatable.format(ndefMessage);
            ret = true;
        } catch (IOException | FormatException e) {
            e.printStackTrace();
        } finally {
            try {
                ndefFormatable.close();
            } catch (IOException e) {
                e.printStackTrace();
            }
        }
    }
} else {
    Log.e(LOGCAT_TAG, "can not format this card");
}
}

```

```

    }
    return ret;
}

private boolean writeNdef(Tag tag) {
    boolean ret = false;
    byte[] ndefMsgPayloadBytes = "Hello NQuire300!".getBytes();
    NdefMessage ndefMessage = new NdefMessage(new NdefRecord[]{NdefRecord.createExternal("nlsan",
"teststring", ndefMsgPayloadBytes)});
    Ndef ndef = Ndef.get(tag);
    if (ndef==null) {
        Log.d(LOGCAT_TAG, "Invalid NDEF card, format it");
        ret = formatNdef(tag, ndefMessage);
    } else {
        try {
            ndef.connect();
            if (ndef.isConnected() && ndef.isWritable()) {
                if (ndefMessage.getByteArrayLength()<=ndef.getMaxSize()) {
                    ndef.writeNdefMessage(ndefMessage);
                    ret = true;
                } else {
                    Log.e(LOGCAT_TAG, "NdefMessage is too long");
                }
            } else {
                Log.e(LOGCAT_TAG, "Not connected or Not Writable");
            }
        } catch (IOException | FormatException e) {
            e.printStackTrace();
        } finally {
            try {
                ndef.close();
            } catch (IOException e) {
                e.printStackTrace();
            }
        }
    }
    return ret;
}
}

```

2) Read NDEF Data from an NFC Tag

Read the written NDEF message on the dedicated thread and display the results on the main thread.

```
@Override
protected void onNewIntent(Intent intent) {
    super.onNewIntent(intent);

    final Tag tag = intent.getParcelableExtra(NfcAdapter.EXTRA_TAG);
    if (tag!=null) {
        String cardNr = byteArrayToHexString(tag.getId());
        Log.d(LOGCAT_TAG, "card Number:"+cardNr);

        //doWriteNdefTest(tag);
        doReadNdefTest(tag);
    }
}

private void doReadNdefTest(final Tag tag) {
    runOnNfcThread(new Runnable() {
        @Override
        public void run() {
            Ndef ndef = Ndef.get(tag);
            if (ndef==null) {
                Log.e(LOGCAT_TAG, "Invalid NDEF card. Can not test read.");
                return;
            }
            try {
                ndef.connect();
                NdefMessage ndefMessage = ndef.getNdefMessage();
                if (ndefMessage==null) {
                    Log.e(LOGCAT_TAG, "No NDEF message in the tag.");
                    return;
                }
                NdefRecord record = ndefMessage.getRecords()[0];
                if (record.getTnf()!=NdefRecord.TNF_EXTERNAL_TYPE) {
                    Log.e(LOGCAT_TAG, "No test record in the tag.");
                    return;
                }
                final String domainType = new String(record.getType());
                final String payload = new String(record.getPayload());
                runOnUiThread(new Runnable() {
                    @Override
                    public void run() {
                        tvNfcMsg.setText(domainType+"\n"+payload);
                    }
                });
            } catch (Exception e) {
                Log.e(LOGCAT_TAG, "Exception: " + e.getMessage());
            }
        }
    });
}
```

```

        }
    });
} catch (IOException | FormatException e) {
    e.printStackTrace();
} finally {
    try {
        ndef.close();
    } catch (IOException e) {
        e.printStackTrace();
    }
}
}
});
}

```

3. Read/Write Non-NDEF Tags

Android also provides APIs for reading/writing non-NDEF tags directly. You may use these APIs to read/write tags in your desired format. The following shows an example of reading/writing an Mifare Ultralight tag.

1) Directly Write to Mifare Ultralight page

The first 4 pages of Mifare Ultralight are for OTP, manufacturer data, and locking bits. The following example shows how to write data to its next 4 pages on the dedicated thread and display the results on the main thread.

```

@Override
protected void onNewIntent(Intent intent) {
    super.onNewIntent(intent);

    final Tag tag = intent.getParcelableExtra(NfcAdapter.EXTRA_TAG);
    if (tag!=null) {
        String cardNr = byteArrayToHexString(tag.getId());
        Log.d(LOGCAT_TAG, "card Number:"+cardNr);
        doMifareUltralightWriteTest(tag);
    }
}

private void doMifareUltralightWriteTest(final Tag tag) {
    runOnNfcThread(new Runnable() {
        @Override
        public void run() {
            boolean testResult = false;
            MifareUltralight mifareUltralight = MifareUltralight.get(tag);
            if (mifareUltralight==null) {
                Log.e(LOGCAT_TAG, "Not MifareUltralight.");
            }
        }
    });
}

```

2) Directly read Mifare Ultralight page

MifareUltralight.readPages can read 4 pages in one go. Perform read operations on the dedicated thread and display the results on the main thread.

```
@Override
protected void onNewIntent(Intent intent) {
    super.onNewIntent(intent);

    final Tag tag = intent.getParcelableExtra(NfcAdapter.EXTRA_TAG);
    if (tag!=null) {
        String cardNr = byteArrayToHexString(tag.getId());
        Log.d(LOGCAT_TAG, "card Number:"+cardNr);
        doMifareUltralightReadTest(tag);
    }
}

private void doMifareUltralightReadTest(final Tag tag) {
    runOnNfcThread(new Runnable() {
        @Override
        public void run() {
            MifareUltralight mifareUltralight = MifareUltralight.get(tag);
            if (mifareUltralight==null) {
                Log.e(LOGCAT_TAG, "Not MifareUltralight.");
                return;
            }
            try {
                mifareUltralight.connect();
                // readPages will read 4 pages
                final String data1 = new String(mifareUltralight.readPages(4));
                runOnUiThread(new Runnable() {
                    @Override
                    public void run() {
                        tvNfcMsg.setText(data1);
                    }
                });
            } catch (IOException e) {
                e.printStackTrace();
            } finally {
                try {
                    mifareUltralight.close();
                } catch (IOException e) {
                    e.printStackTrace();
                }
            }
        }
    });
}
```

GPIO Programming

The NQire300 has 8 GPIO pins (4 for input, 4 for output). Application can read and control those pins as per actual needs.

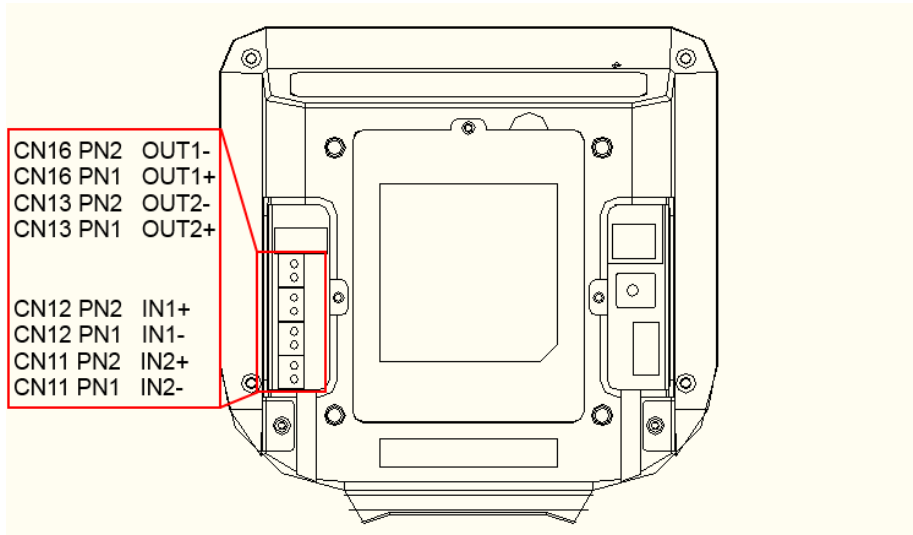

The following code example shows how to read/write and set the GPIO pins.

```
/**  
 * Read and write nquire gpio  
 */  
public class GpioUtils {  
    public static final String OUTPIN1 = "/sys/class/gpio/gpio163/value";  
    public static final String OUTPIN2 = "/sys/class/gpio/gpio165/value";  
    public static final String INPIN1 = "/sys/class/switch/INPIN1/state";  
    public static final String INPIN2 = "/sys/class/switch/INPIN2/state";  
  
    public static boolean setOutPinHigh(String pin, boolean high) {  
        FileOutputStream out = null;  
        boolean ret = false;  
        try {  
            out = new FileOutputStream(pin);  
            out.write(high ? '1' : '0');  
            ret = true;  
        } catch (IOException e) {  
            e.printStackTrace();  
        } finally {  
            if (out != null) {  
                try {  
                    out.close();  
                } catch (IOException e) {  

```

```

        e.printStackTrace();
    }
}
return ret;
}

public static boolean isPinHigh(String pin) throws Exception {
    FileInputStream in = null;
    boolean ret = false;
    try {
        in = new FileInputStream(pin);
        int value = in.read();
        switch (value) {
            case '1':
                ret = true;
                break;
            case '0':
                ret = false;
                break;
            default:
                throw new Exception(pin + ", invalid value: " + value);
        }
    } finally {
        if (in != null) {
            try {
                in.close();
            } catch (IOException e) {
                e.printStackTrace();
            }
        }
    }
    return ret;
}
}
}

```

Launch Application on Boot

By default, the NQuire300 start NQuire200-compatible CIT at startup. If you want to run your own application instead of CIT at startup, follow the steps described below.

1. Open NQuire Configuration tool homepage in a web browser. Then click “Miscellaneous” in the menu on the left pane and select “No” for the “Enable launch CIT on boot” item.

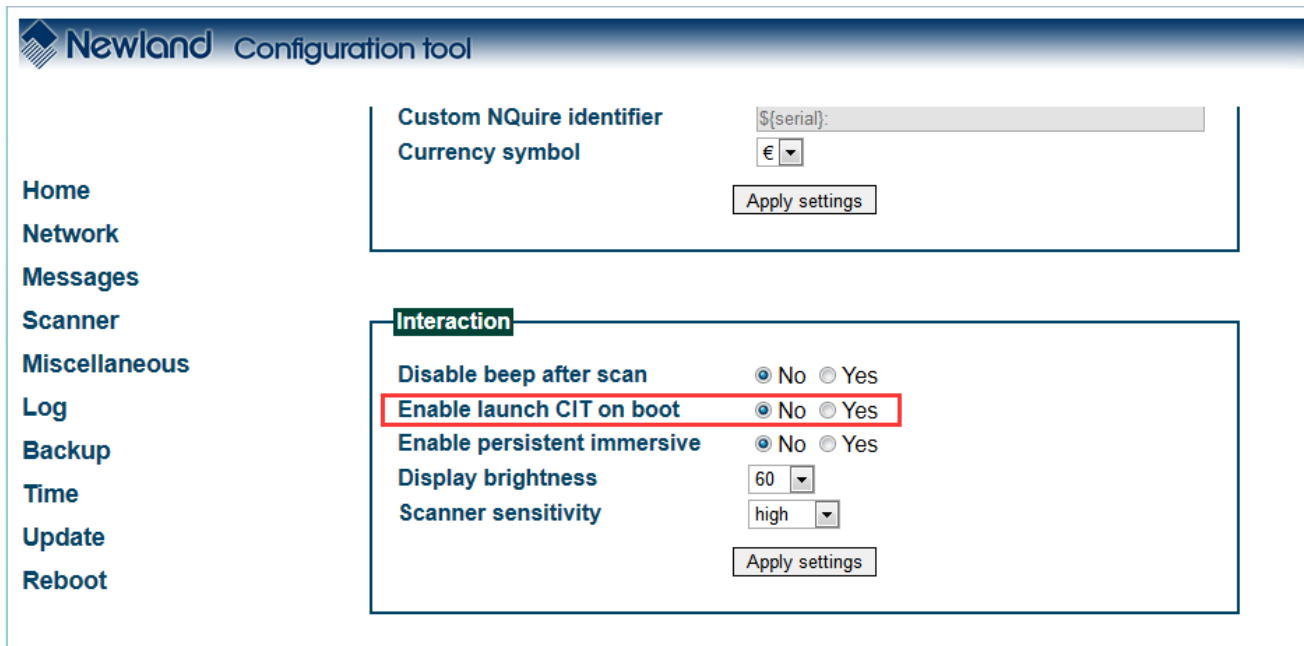

The screenshot shows the Newland Configuration tool interface. On the left is a navigation menu with options: Home, Network, Messages, Scanner, Miscellaneous (selected), Log, Backup, Time, Update, and Reboot. The main content area is divided into two sections. The top section, titled 'Custom NQuire identifier', contains a text input field for the serial number, a dropdown for the currency symbol (set to '€'), and an 'Apply settings' button. The bottom section, titled 'Interaction', contains several settings: 'Disable beep after scan' (radio buttons for No and Yes), 'Enable launch CIT on boot' (radio buttons for No and Yes, highlighted with a red box), 'Enable persistent immersive' (radio buttons for No and Yes), 'Display brightness' (a dropdown menu set to 60), and 'Scanner sensitivity' (a dropdown menu set to high). An 'Apply settings' button is located at the bottom of the Interaction section.

2. Create a new class **MyReceiver**. In its **onReceive()** method you can start your desired app component or activity. To launch the activity as a main application entry, you need to add the flags **Intent.FLAG_ACTIVITY_NEW_TASK**.

```
public class MyReceiver extends BroadcastReceiver {  
    public MyReceiver() {  
    }  
  
    @Override  
    public void onReceive(Context context, Intent intent) {  
        Intent activityIntent = new Intent(context, MainActivity.class);  
        activityIntent.addFlags(Intent.FLAG_ACTIVITY_NEW_TASK);  
        context.startActivity(activityIntent);  
    }  
}
```

3. Add the **android.permission.RECEIVE_BOOT_COMPLETED** permission to the AndroidManifest.xml and register a broadcast receiver listening for the boot complete event in the AndroidManifest.xml.

```
<uses-permission android:name="android.permission.RECEIVE_BOOT_COMPLETED" />
```

```
<receiver  
  android:name=".MyReceiver"  
  android:enabled="true"  
  android:exported="false">  
  <intent-filter>  
    <action android:name="android.intent.action.BOOT_COMPLETED"/>  
  </intent-filter>  
</receiver>
```



Newland

SCANNING MADE SIMPLE

Newland EMEA HQ

+31 (0) 345 87 00 33
info@newland-id.com
newland-id.com

D-A-C-H

+49 (6) 182 82916-16
info@newland-id.de

Benelux

+31 (0) 345 87 00 33
benelux@newland-id.com

Italy

+39 (0) 342 0562227
italy@newland-id.com

United Kingdom

+44 (0) 1442 212020
sales@newland-id.co.uk

South Africa

Gauteng: +27 (0) 11 553 8010
Cape Town: +27 (0) 21 9140819
info@newland-id.co.za

Turkey

+90 (0) 544 538 40 49
turkey@newland-id.com

France

+39 (0) 345 8804096
france@newland-id.com

Ibérica

+34 (0) 93 303 74 66
info@newland-id.es

Nordic & Baltic

+46 (0) 70 88 47 767
nordic@newland-id.com

Russia

8 (800) 100 46 22
russia@newland-id.com

Middle East

+39 (0) 345 8804096
middleeast@newland-id.com

Iran

+90 (0) 544 538 40 49
iran@newland-id.com